

動作範囲
スケール 1:10

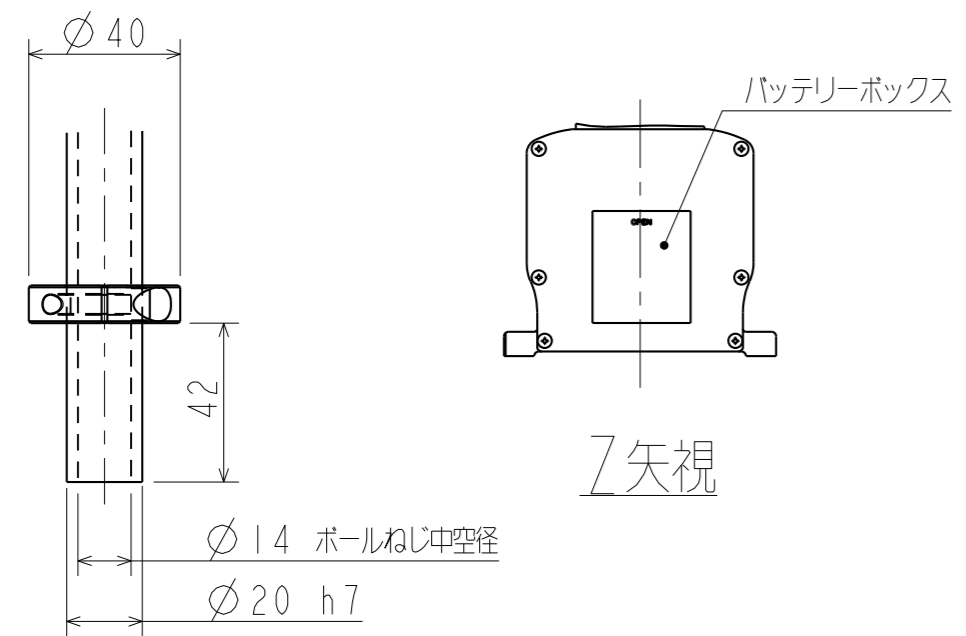

ハンド取付部詳細
スケール 1:2

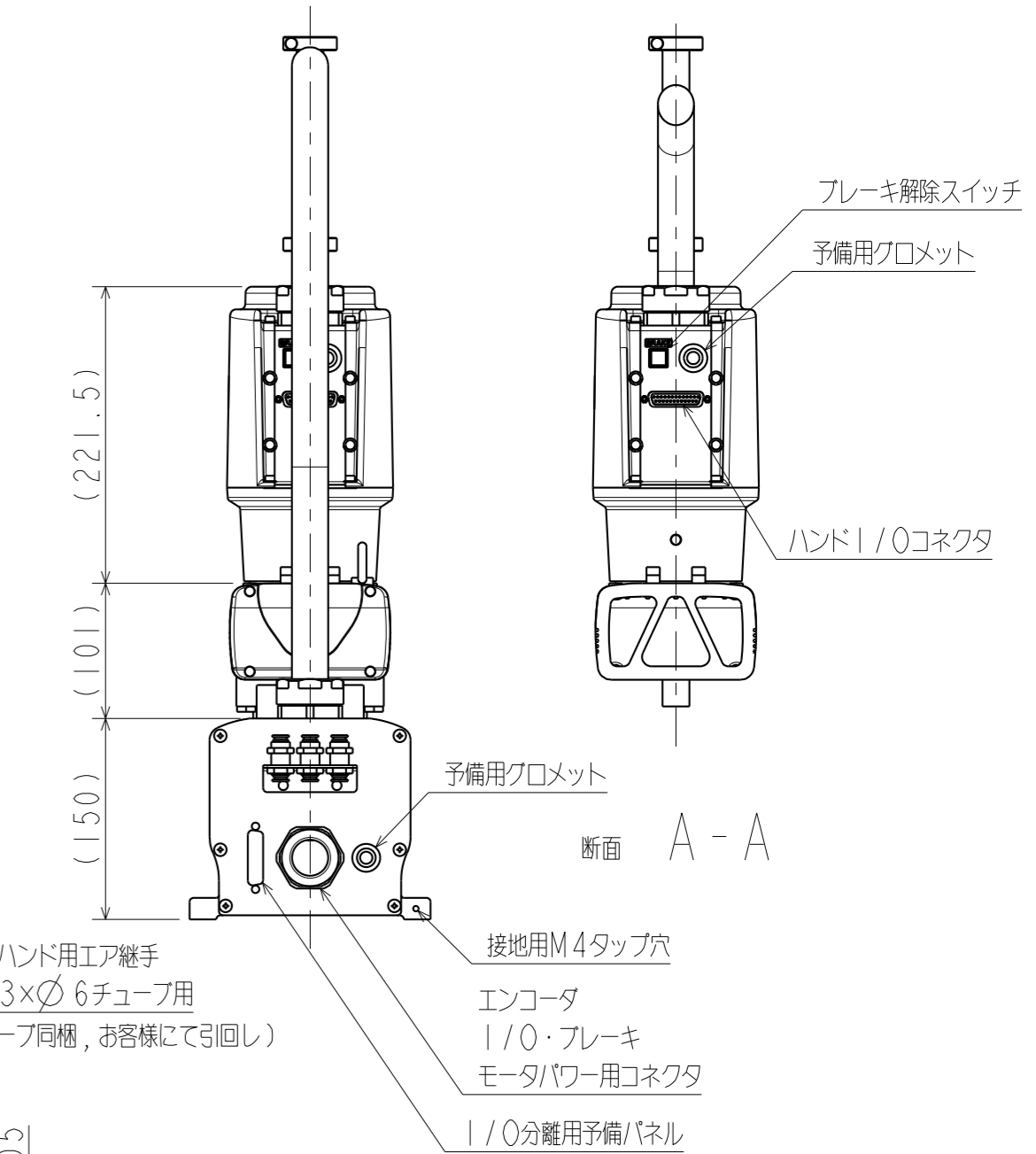
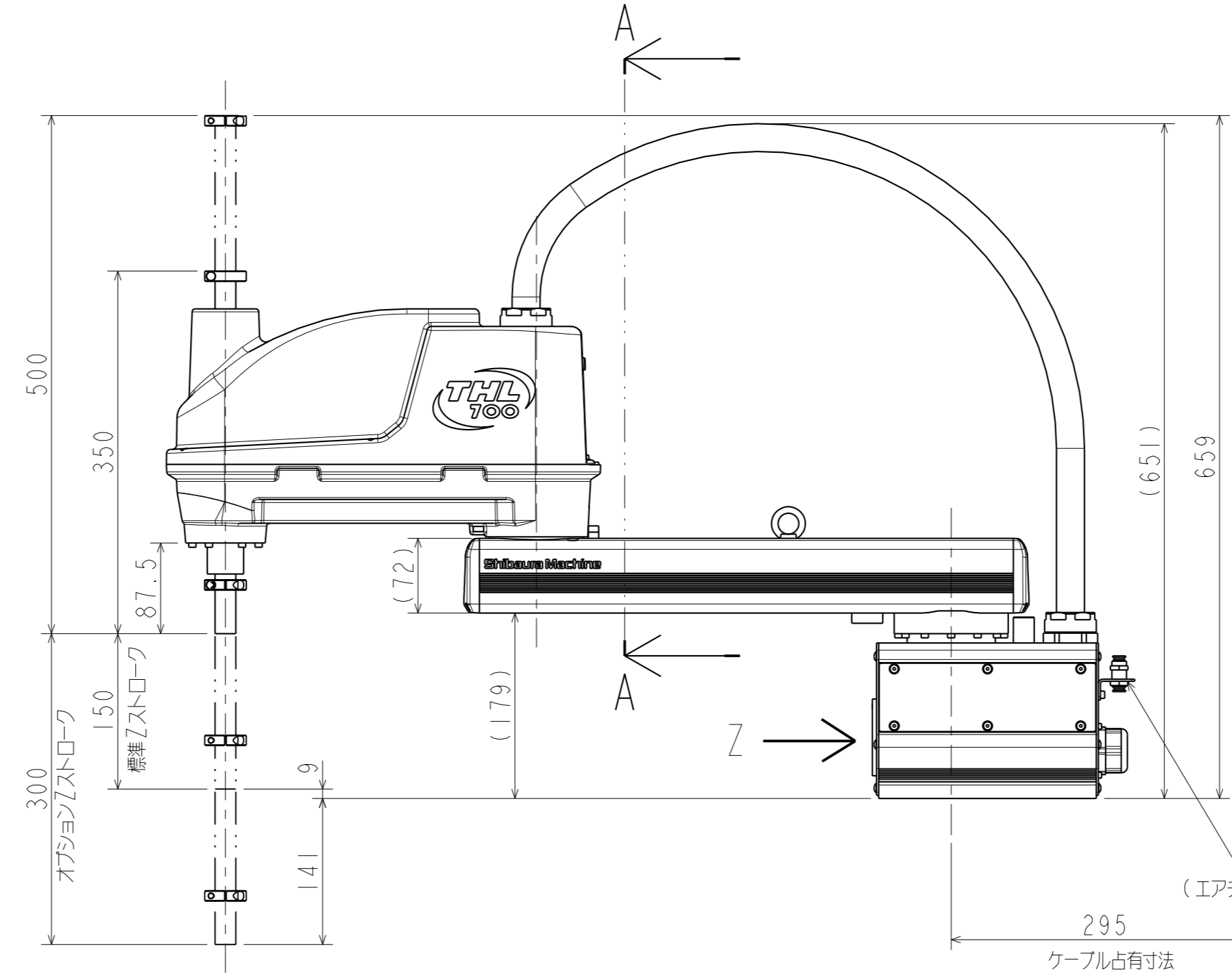
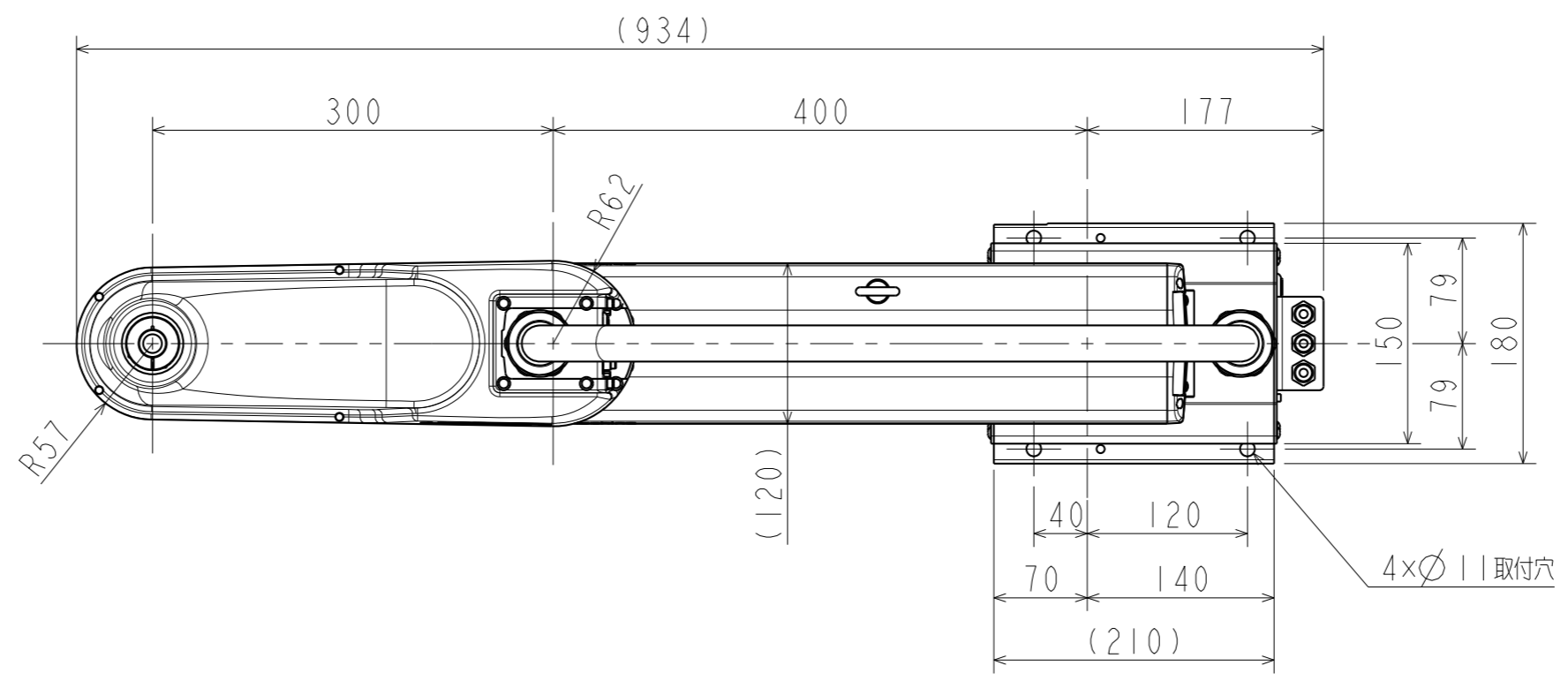
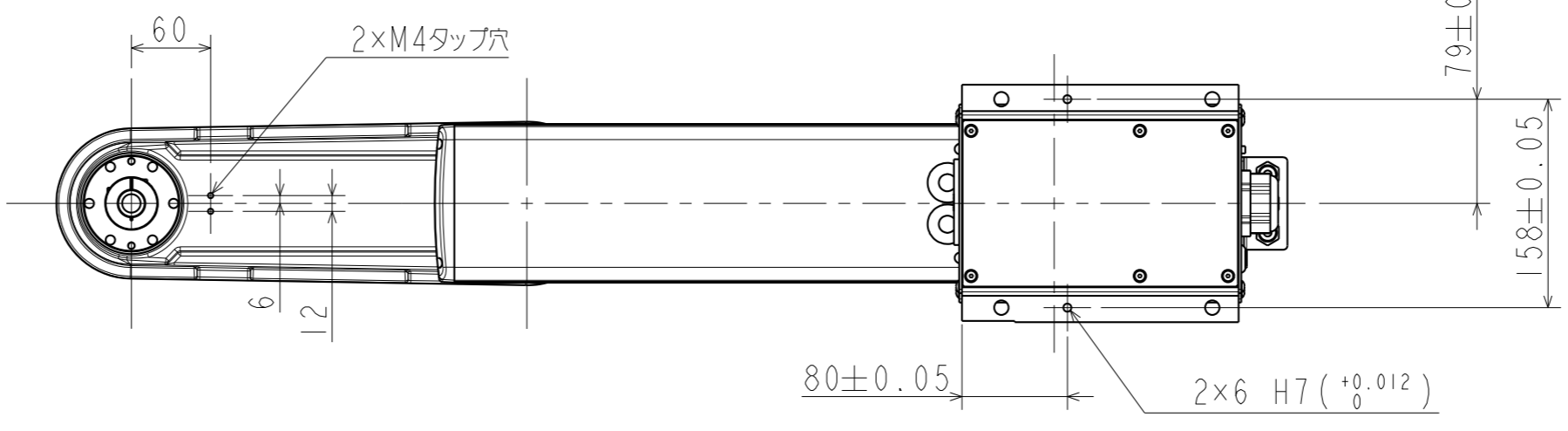

システムロボット 外形図	
スケール 1:5	
THL700	
SHIBAURA MACHINE CO.,LTD.	S-26V84-3