

動作範囲

スケール 1:6

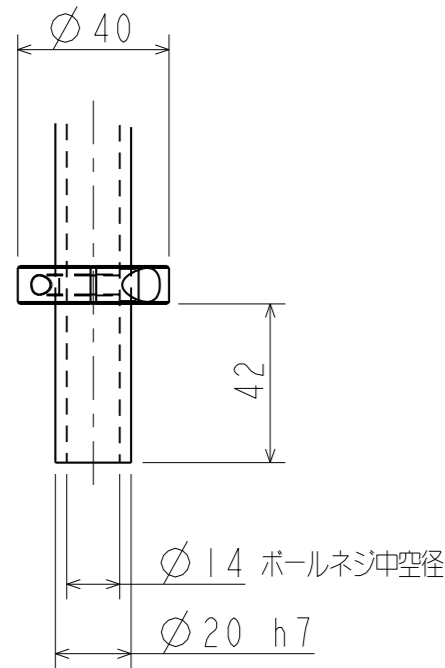

ハンド取付部詳細

スケール 1:2

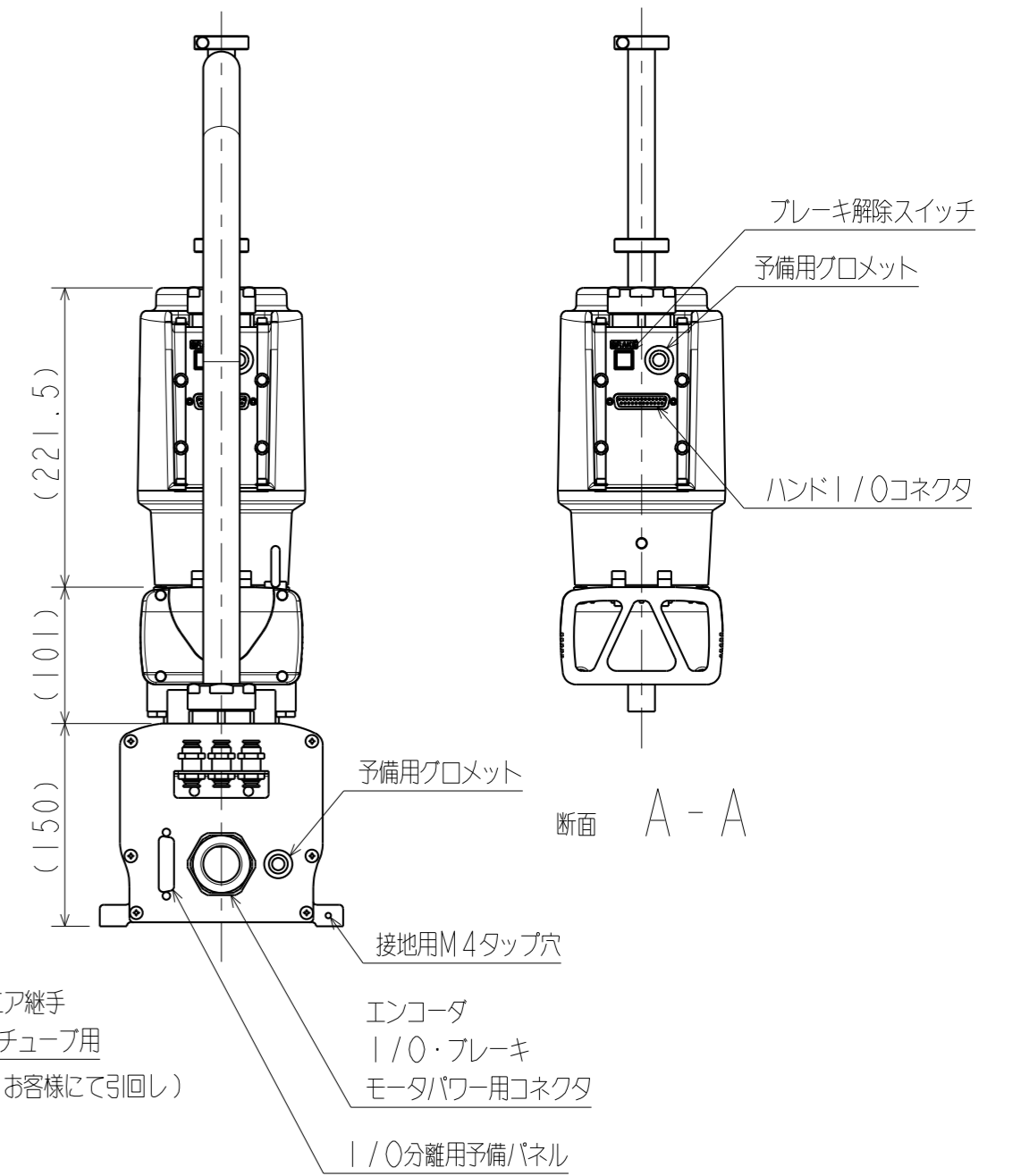
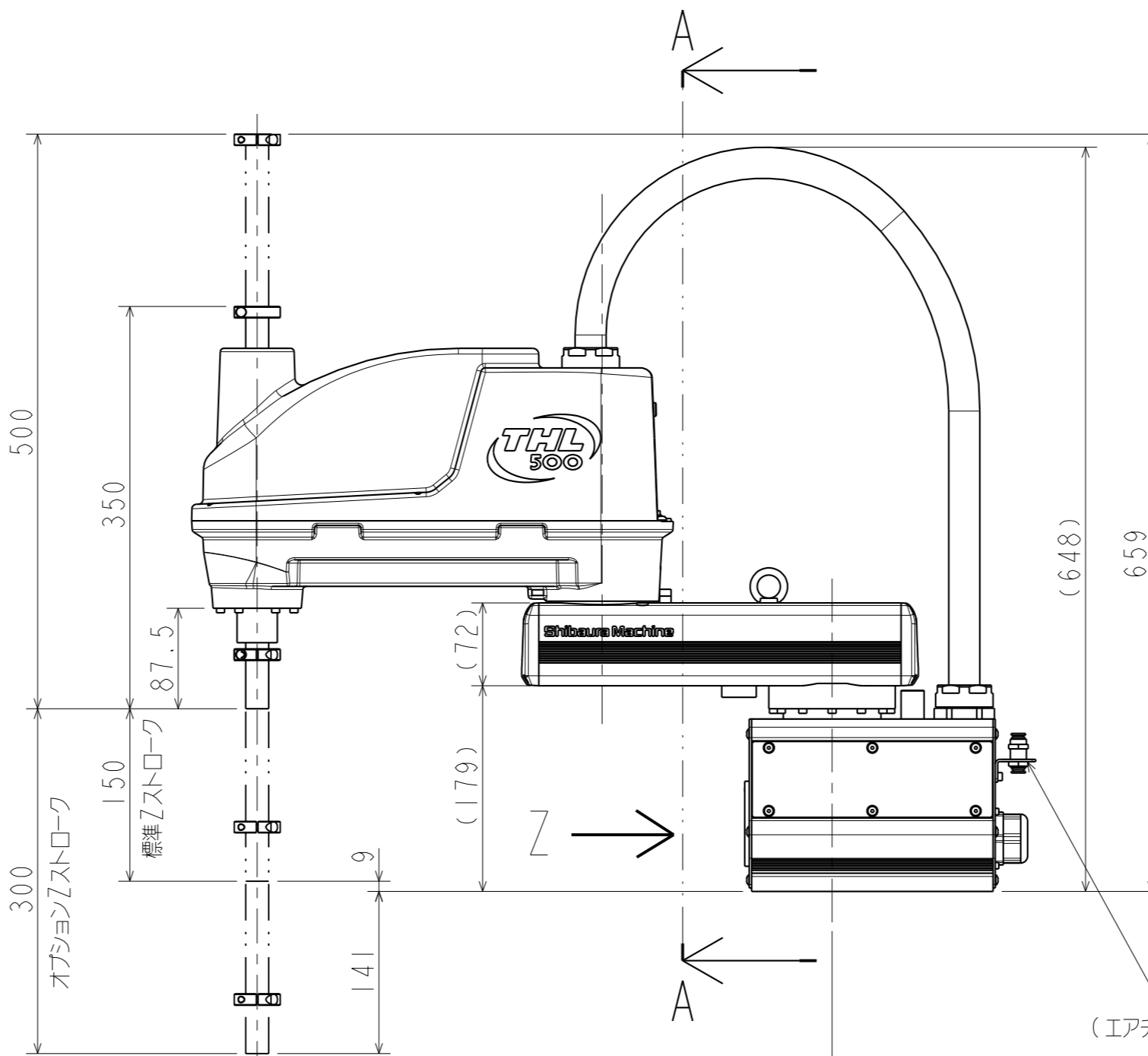
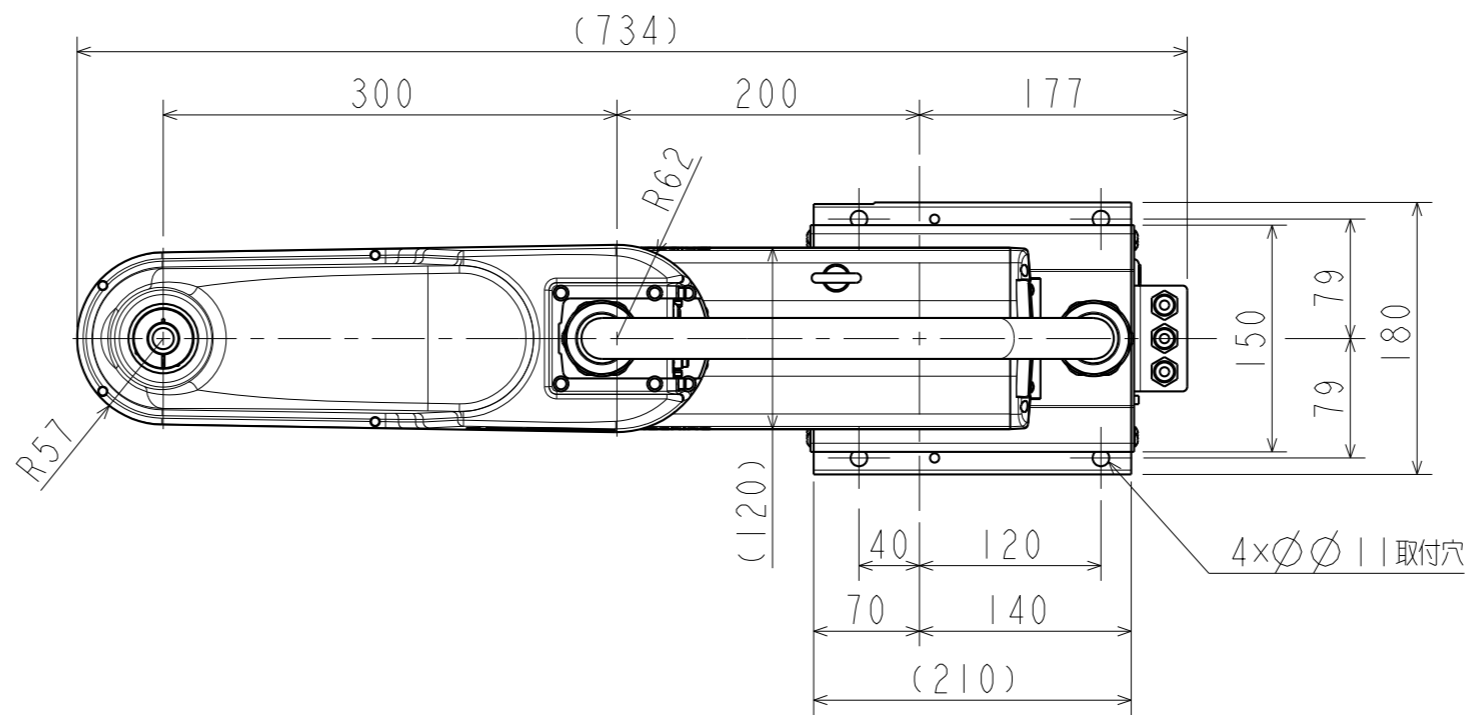
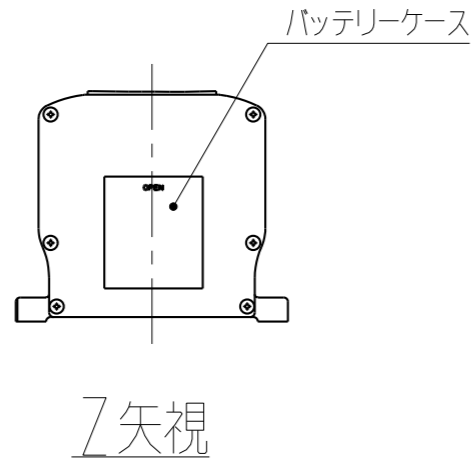

システムロボット 外形図	
スケール 1:5	
THL500	
SHIBAURA MACHINE CO.,LTD.	S-26V82-3