

Move envelope

Scale 1:10

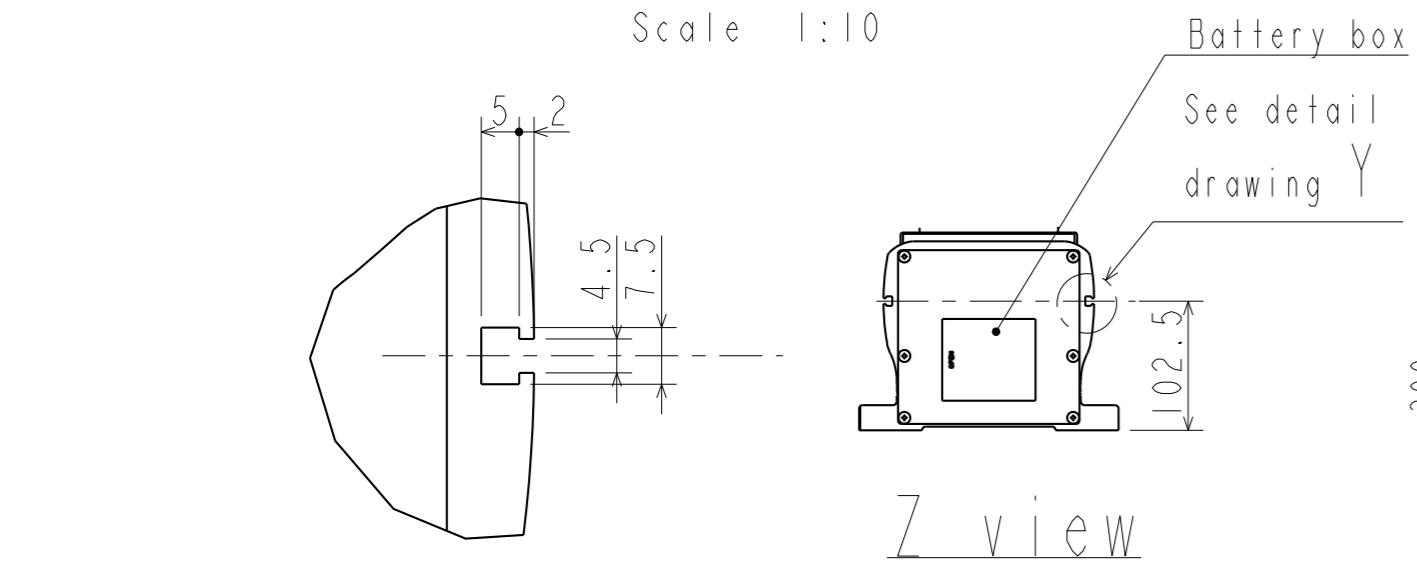

Detail drawing Y 2 location
(Detail of T-slot for mounting peripheral Device)
Scale 1:1

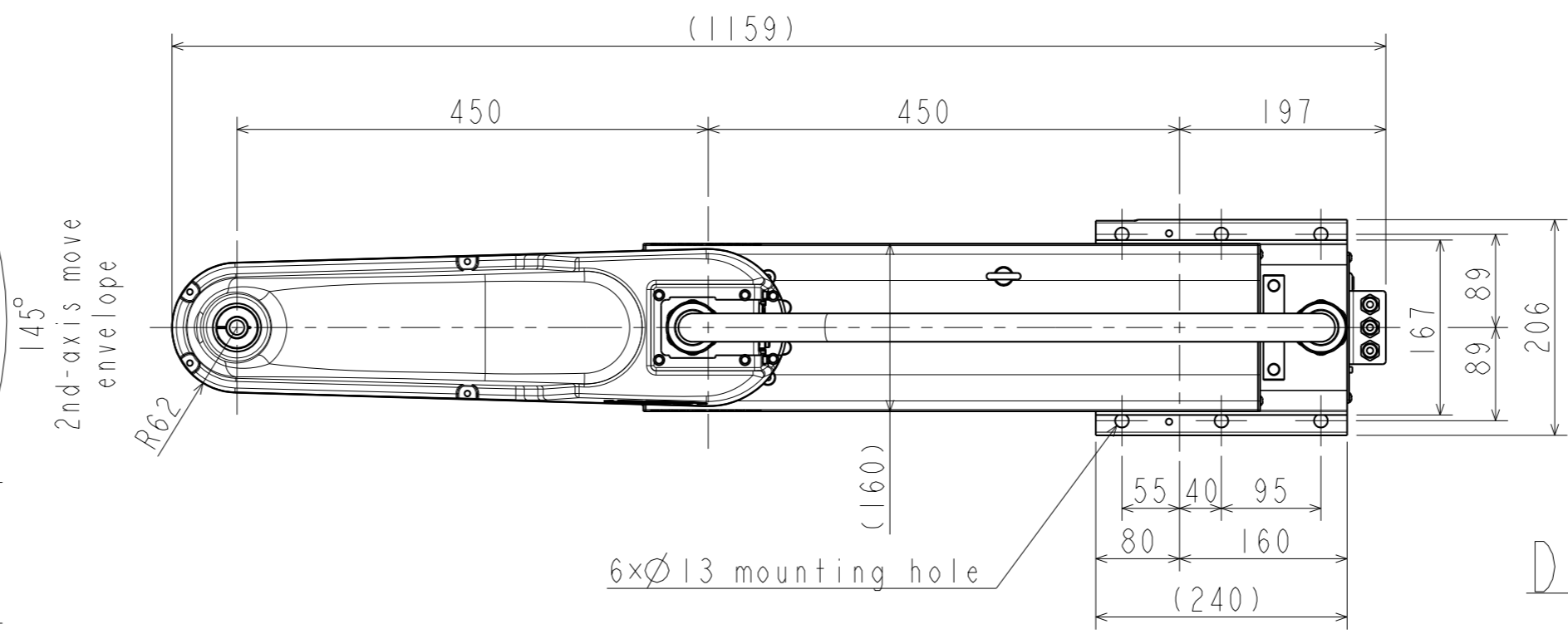

Detail installation view of hand

Scale 1:2

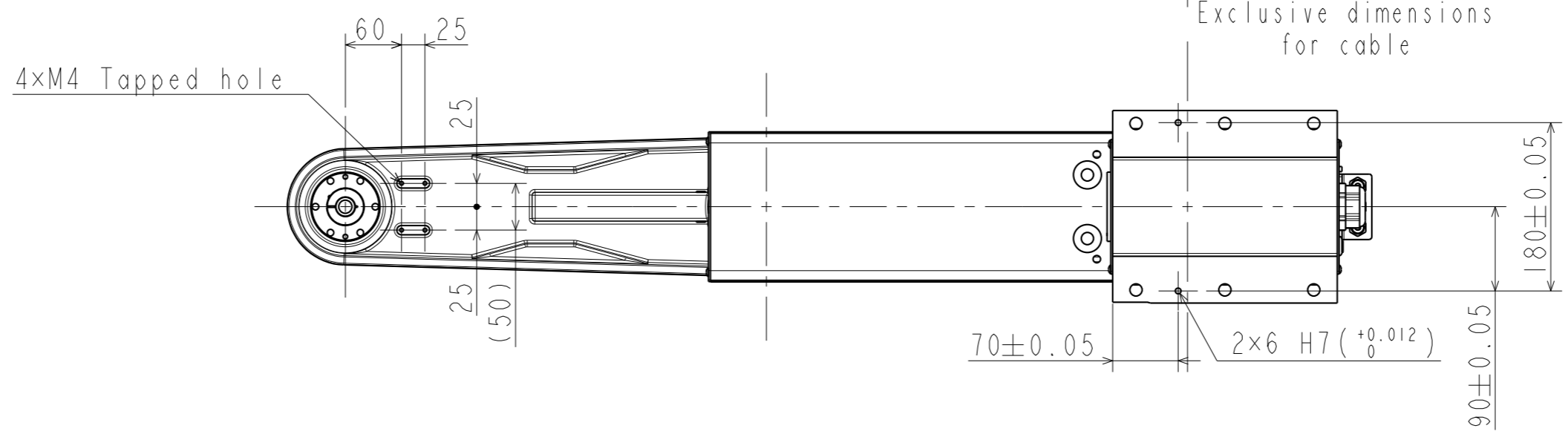
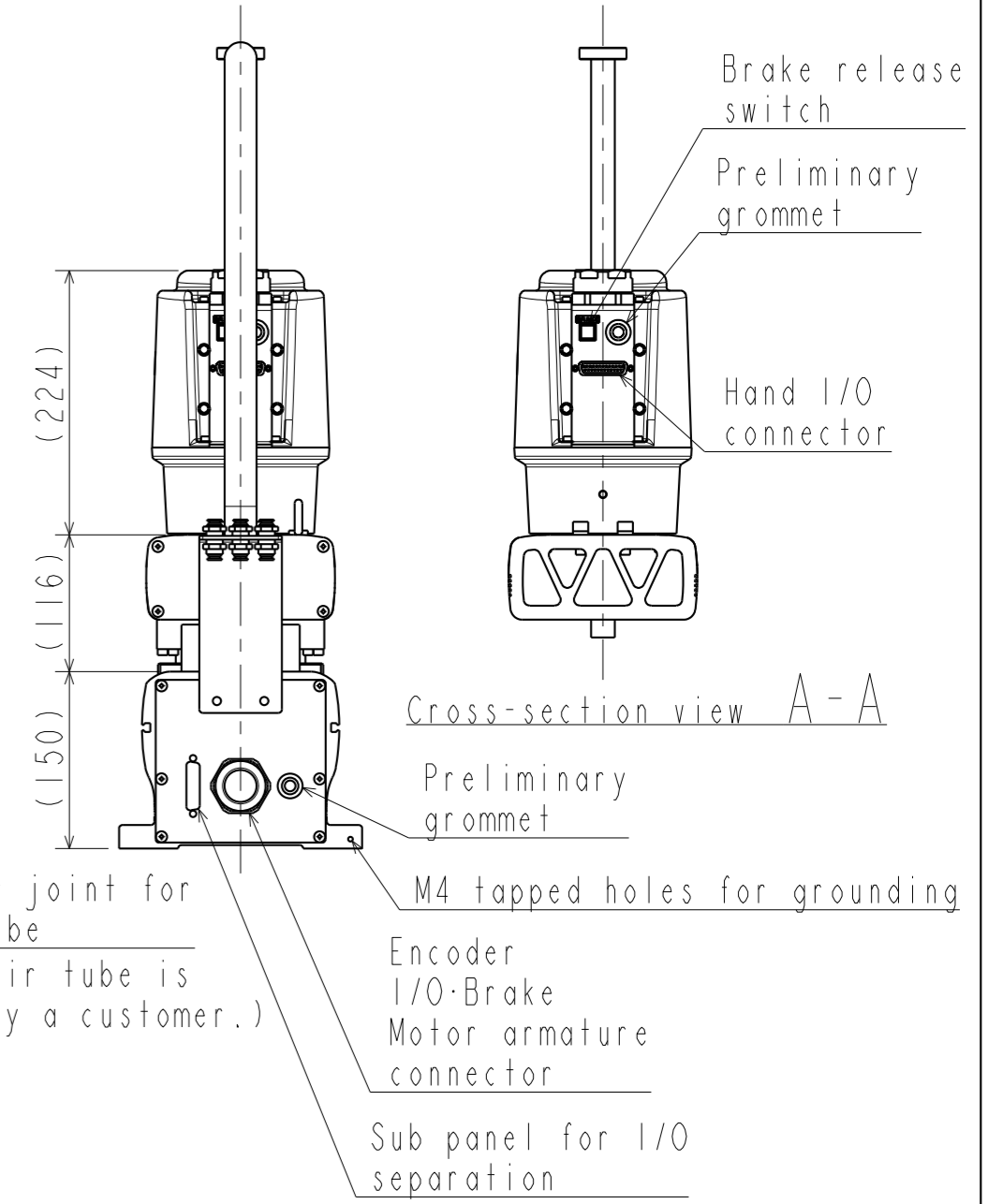
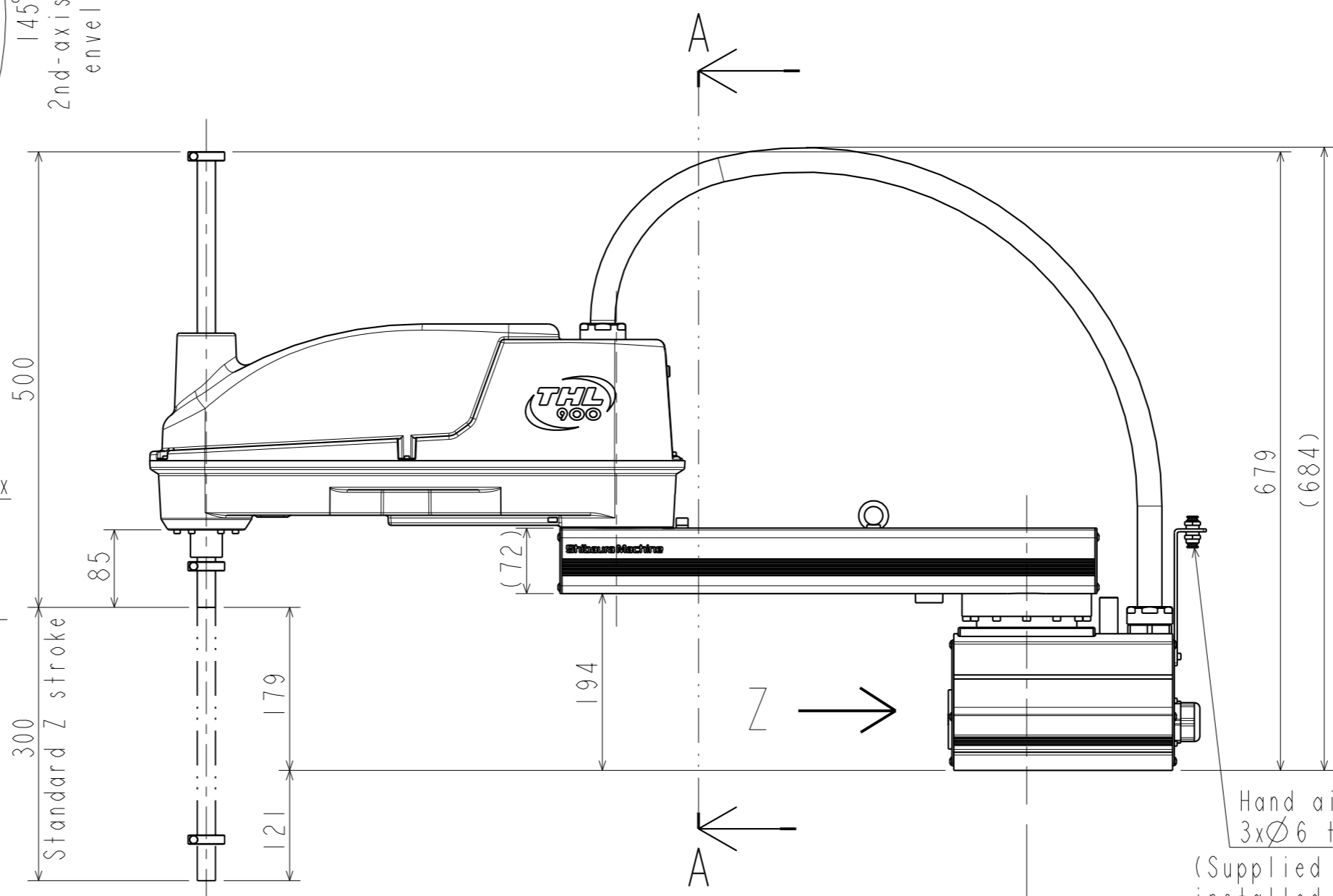
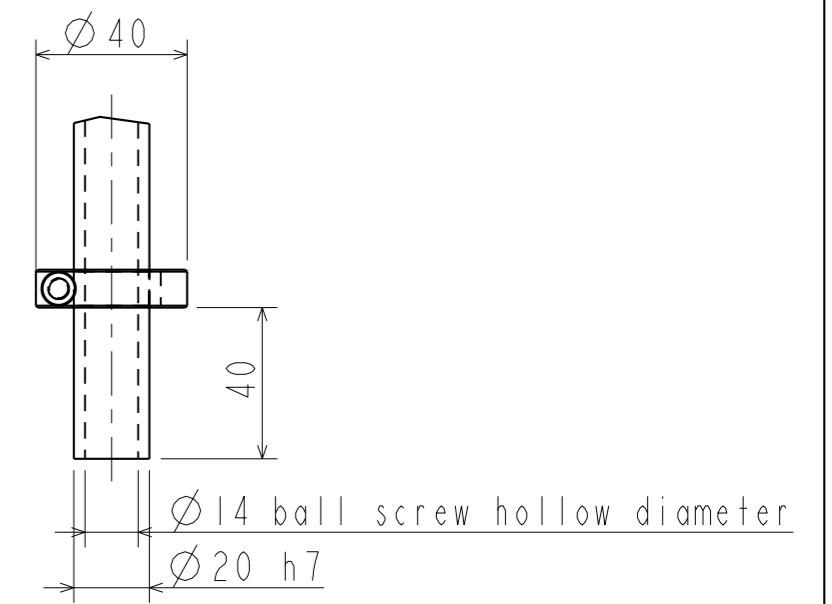

System Robot Outline	
Scale 1:6	
THL900	
SHIBURA MACHINE CO., LTD.	S-2GA82-2